







## EMILE - Espejo luz led



-  IP44
-  Iluminación de bajo consumo. Led Samsung.
-  Marcado CE
-  3 años de garantía
-  Espejo retroiluminado
-  Espejo multiposición

### Características Técnicas

	500x1300	700x1100
Kelvin	5700 (cool light)	
Lúmenes	612	
Wattios	20	
Anticorrosión	No	
Eficiencia energética	G	
Espesor de la luna	4 mm	
CRI	> 90	
Vida útil	3000 h	

### Dimensiones producto

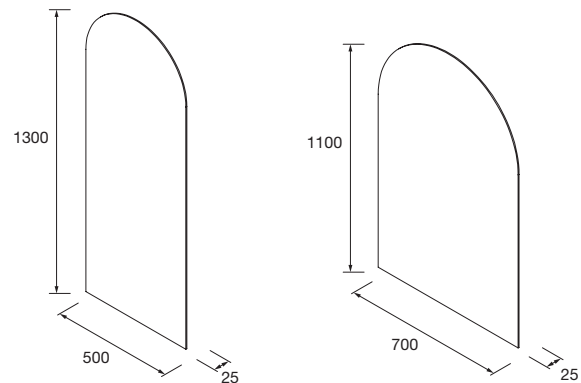

### Dimensiones y peso embalaje

	500x1300	700x1100
Longitud (mm)	670	7770
Profundidad (mm)	75	
Altura (mm)	1370	1170
Peso neto (kg)	6,8	7,7
Peso bruto (kg)	7,9	8,8

### Medidas de instalación

